

## HEXFRED™

## Ultrafast, Soft Recovery Diode

### Features

- Ultrafast Recovery
- Ultrasoft Recovery
- Very Low  $I_{RRM}$
- Very Low  $Q_{rr}$
- Specified at Operating Conditions

### Benefits

- Reduced RFI and EMI
- Reduced Power Loss in Diode and Switching Transistor
- Higher Frequency Operation
- Reduced Snubbing
- Reduced Parts Count

### Description

International Rectifier's HFA15TB60 is a state of the art ultra fast recovery diode. Employing the latest in epitaxial construction and advanced processing techniques it features a superb combination of characteristics which result in performance which is unsurpassed by any rectifier previously available. With basic ratings of 600 volts and 8 amps per Leg continuous current, the HFA15TB60 is especially well suited for use as the companion diode for IGBTs and MOSFETs. In addition to ultra fast recovery time, the HEXFRED product line features extremely low values of peak recovery current ( $I_{RRM}$ ) and does not exhibit any tendency to "snap-off" during the  $t_b$  portion of recovery. The HEXFRED features combine to offer designers a rectifier with lower noise and significantly lower switching losses in both the diode and the switching transistor. These HEXFRED advantages can help to significantly reduce snubbing, component count and heatsink sizes. The HEXFRED HFA15TB60 is ideally suited for applications in power supplies and power conversion systems (such as inverters), motor drives, and many other similar applications where high speed, high efficiency is needed.

$$V_R = 600V$$

$$V_F = 1.7V$$

$$Q_{rr}^* = 84nC$$

$$di_{(rec)M}/dt^* = 188A/\mu s$$

\* 125°C



**TO-220AC**



**TO-262**

### Absolute Maximum Ratings

	Parameter	Max	Units
$V_R$	Cathode-to-Anode Voltage	600	V
$I_F @ T_C = 100^\circ C$	Continuous Forward Current	15	A
$I_{FSM}$	Single Pulse Forward Current	150	
$I_{FRM}$	Maximum Repetitive Forward Current	60	
$P_D @ T_C = 25^\circ C$	Maximum Power Dissipation	74	W
$P_D @ T_C = 100^\circ C$	Maximum Power Dissipation	29	
$T_J$	Operating Junction and	- 55 to +150	C
$T_{STG}$	Storage Temperature Range		

**Electrical Characteristics @ T<sub>J</sub> = 25°C (unless otherwise specified)**

	Parameter	Min	Typ	Max	Units	Test Conditions
V <sub>BR</sub>	Cathode Anode Breakdown Voltage	600			V	I <sub>R</sub> = 100μA
V <sub>FM</sub>	Max Forward Voltage		1.3	1.7	V	I <sub>F</sub> = 15A
			1.5	2.0		I <sub>F</sub> = 30A See Fig. 1
			1.2	1.6		I <sub>F</sub> = 15A, T <sub>J</sub> = 125°C
I <sub>RM</sub>	Max Reverse Leakage Current		1.0	10	μA	V <sub>R</sub> = V <sub>R</sub> Rated See Fig. 2
			400	1000		T <sub>J</sub> = 125°C, V <sub>R</sub> = 0.8 x V <sub>R</sub> Rated
C <sub>T</sub>	Junction Capacitance		25	50	pF	V <sub>R</sub> = 200V See Fig. 3
L <sub>S</sub>	Series Inductance		8.0		nH	Measured lead to lead 5mm from package body

**Dynamic Recovery Characteristics @ T<sub>J</sub> = 25°C (unless otherwise specified)**

	Parameter	Min	Typ	Max	Units	Test Conditions
t <sub>rr</sub>	Reverse Recovery Time		19		ns	I <sub>F</sub> = 1.0A, di/dt = 200A/μs, V <sub>R</sub> = 30V T <sub>J</sub> = 25°C T <sub>J</sub> = 125°C
t <sub>rr1</sub>	See Fig. 5, 6 & 16		42	60		
t <sub>rr2</sub>			74	120		
I <sub>RRM1</sub>	Peak Recovery Current		4.0	6.0	A	T <sub>J</sub> = 25°C T <sub>J</sub> = 125°C
I <sub>RRM2</sub>	See Fig. 7 & 8		6.5	10		
Q <sub>rr1</sub>	Reverse Recovery Charge		84	180	nC	T <sub>J</sub> = 25°C T <sub>J</sub> = 125°C
Q <sub>rr2</sub>	See Fig. 9 & 10		241	600		
di <sub>(rec)M</sub> /dt1	Peak Rate of Fall of Recovery Current		188		A/μs	T <sub>J</sub> = 25°C T <sub>J</sub> = 125°C
di <sub>(rec)M</sub> /dt2	During t <sub>b</sub> See Fig. 11 & 12		160			

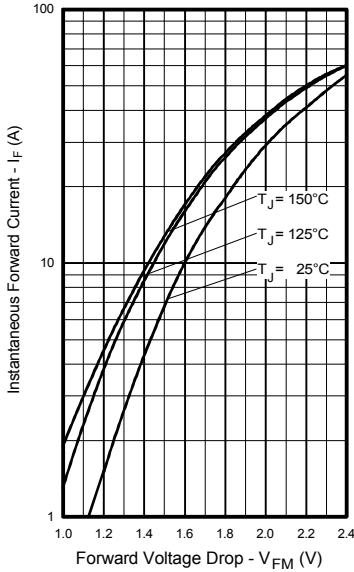
**Thermal - Mechanical Characteristics**

	Parameter	Min	Typ	Max	Units
T <sub>lead</sub> ①	Lead Temperature			300	°C
R <sub>thJC</sub>	Thermal Resistance, Junction to Case			1.7	K/W
R <sub>thJA</sub> ②	Thermal Resistance, Junction to Ambient			80	
R <sub>thCS</sub> ③	Thermal Resistance, Case to Heat Sink		0.5		
Wt	Weight		2.0		g
			0.07		(oz)
T	Mounting Torque		6.0	12	Kg-cm
			5.0	10	lbf•in

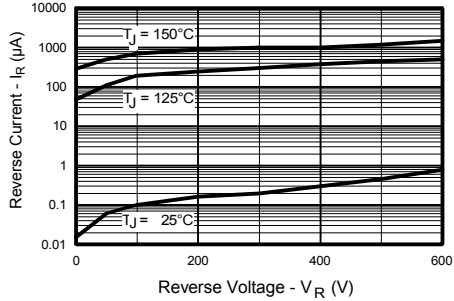
① 0.063 in. from Case (1.6mm) for 10 sec

② Typical Socket Mount

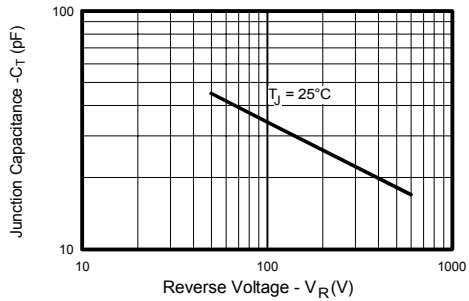
③ Mounting Surface, Flat, Smooth and Greased



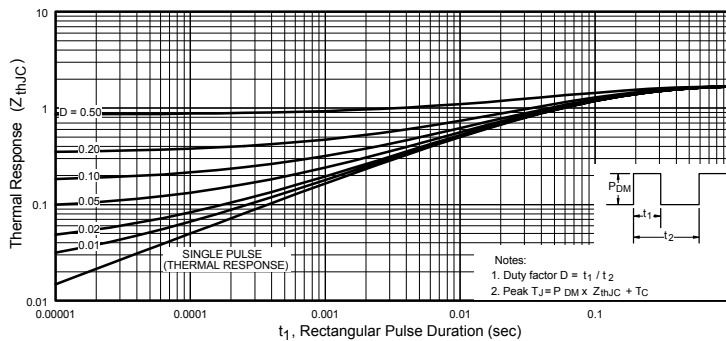
**Fig. 1 - Maximum Forward Voltage Drop vs. Instantaneous Forward Current**



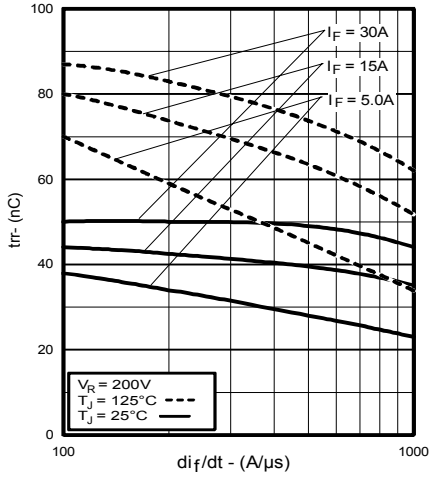
**Fig. 2 - Typical Reverse Current vs. Reverse Voltage**



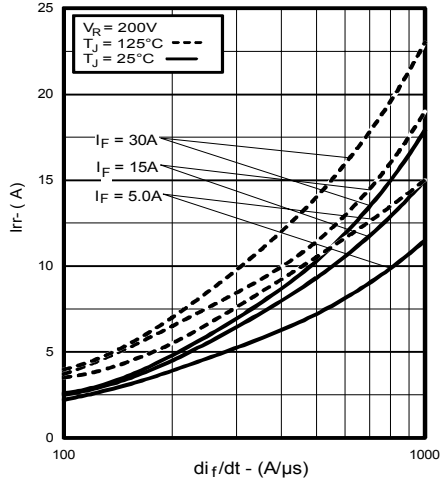
**Fig. 3 - Typical Junction Capacitance vs. Reverse Voltage**



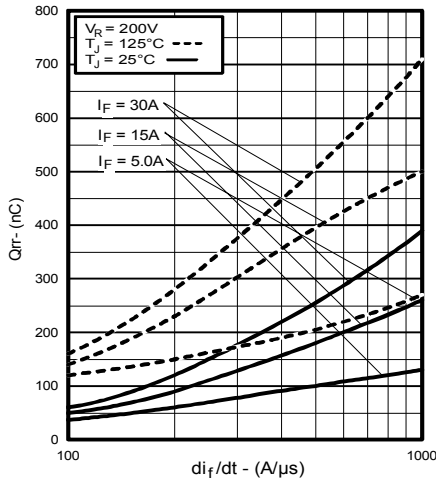
**Fig. 4 - Maximum Thermal Impedance  $Z_{thjC}$  Characteristics**



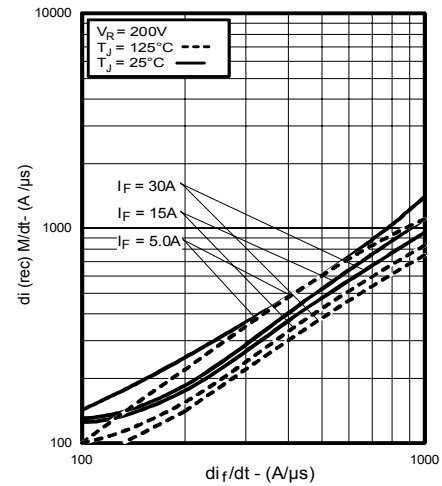
**Fig. 5 - Typical Reverse Recovery vs.  $di_f/dt$**



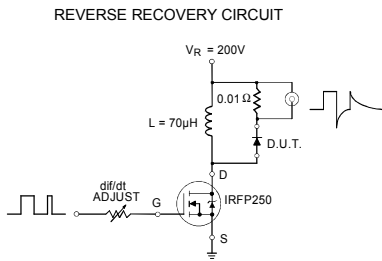
**Fig. 6 - Typical Recovery Current vs.  $di_f/dt$**



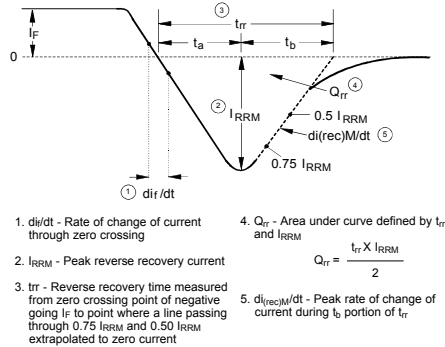
**Fig. 7 - Typical Stored Charge vs.  $di_f/dt$**



**Fig. 8 - Typical  $di_{(rec)M}/dt$  vs.  $di_f/dt$**

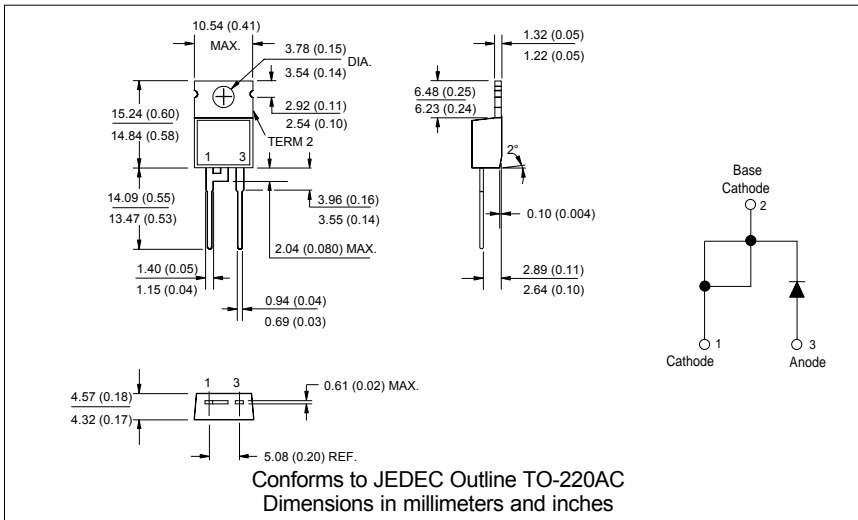


**Fig. 9 - Reverse Recovery Parameter Test Circuit**



**Fig. 10 - Reverse Recovery Waveform and Definitions**

**Outline Table**

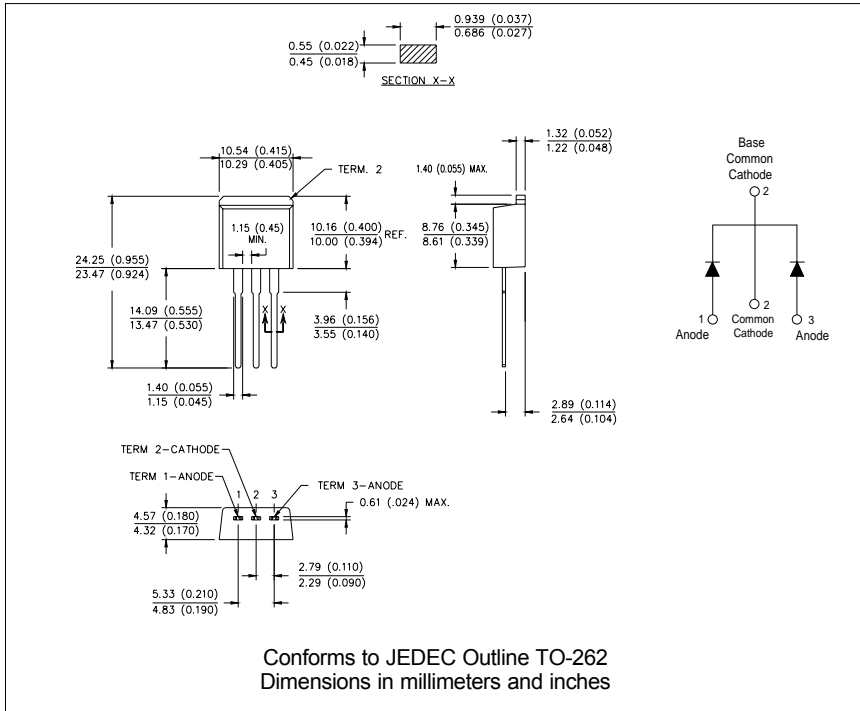


# HFA15TB60, HFA15TB60-1

Bulletin PD-2.334 rev. B 01/02

International  
**IR** Rectifier

## Outline Table



Data and specifications subject to change without notice.  
This product has been designed and qualified for Industrial Level.  
Qualification Standards can be found on IR's Web site.

International  
**IR** Rectifier

**IR WORLD HEADQUARTERS:** 233 Kansas St., El Segundo, California 90245, USA Tel: (310) 252-7105

TAC Fax: (310) 252-7309

Visit us at [www.irf.com](http://www.irf.com) for sales contact information. 01/02